



BAYTOWN II SOLAR LAMP WITH GS LED SOLAR BULB

US Patent # 7172307

US Patent # 9458970

Instruction Manual

Model: GS-105B-FPW



Visit our website or download the latest version of your instruction manual:

www.gamasonic.com or www.gamasonic.com/user-guides

Introduction

Thank you for your purchase. **GAMA SONIC®** solar charged accent lighting eliminates the problems associated with most solar lighting available today. **GAMA SONIC®** solar charged lights are brighter and last all night with a typical solar charge. Unique design, superior light output and numerous installation options confirm the outstanding value of our product.

GAMA SONIC® has been recognized as a worldwide leader in the lighting industry for over 20 years. The company also offers unique multi-purpose rechargeable products that range from party lights to emergency lighting products.

For technical assistance and more information call our Toll Free number:

800-835-4113 (only within the US) or visit our website at: www.gamasonic.com.

Please read the instruction manual carefully to obtain the best results from your purchase.

Solar Lamp Post Location

For optimum light duration throughout the night, it is very important to mount your solar lamp post in a spot where it will receive the maximum amount of sunlight throughout the day.

Note: For best results, the solar lamp post must be charged for two sunny days on the "ON" position.

WARNING: GAMA SONIC® Light bulbs are built and designed for Gama Sonic products only. They are not designed to be used in other electrical sockets.

For the same reason, regular AC and/or Low Voltage bulbs cannot be used in Gama Sonic products.

What's Inside?

Open your package and remove the contents. Check to make sure all pieces are present and accounted for.

- You will need to follow these two steps to disassemble the unit completely

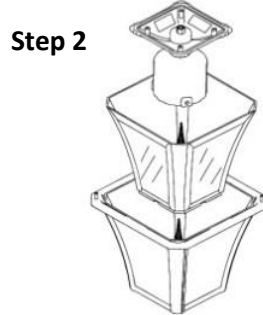
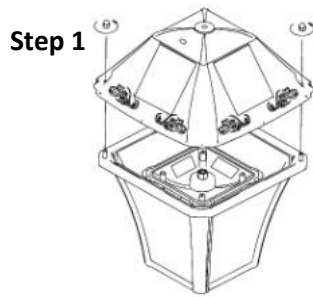

Note: If you're not going to use the 3" fitter base, disassemble the nut and part (H) from part (E).

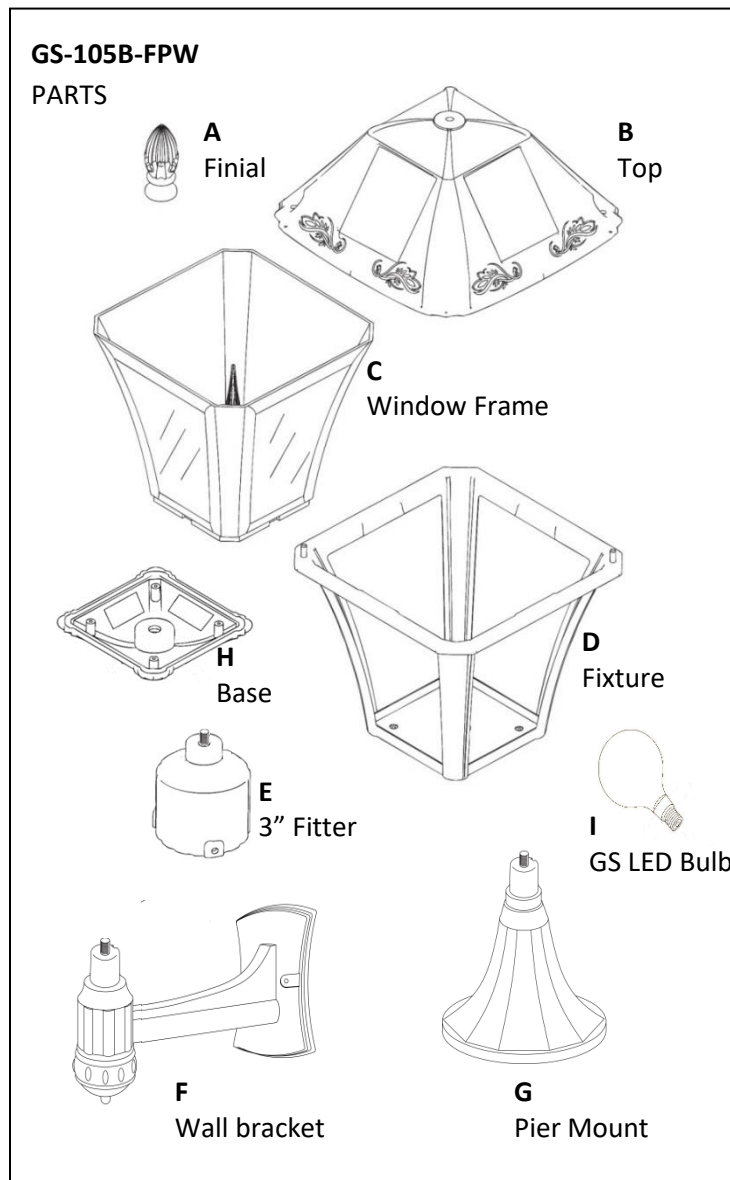
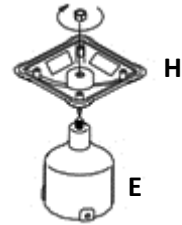

Assembly Instructions:

GS-105B-F:

Note: If you are replacing an existing gas/electric post light, you must consult a certified technician to disconnect them before installation.

1. Attach the fixture (D) to the base (H) with the four supplied screws, as shown on the right.
2. Install the lamp onto your existing 3" post, using the screws provided

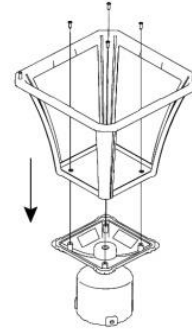

GS-105B-P

Note: There are specific types of screws for specific surfaces. If unsure of the appropriate type of screw to use on your desired surface, please consult a professional.

1. Use a drill to make two holes in the desired surface.
2. Place the screw anchors into the holes, place the lamp in line with the holes and secure with the provided screws.
3. Attach the base (H) to the Pier Mount (G) with the nut (Fig.1).
4. Attach the fixture (D) to the base (H) with the four supplied screws, as shown (Fig.2).

Fig.1

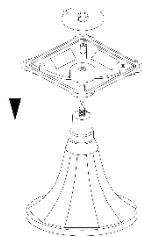
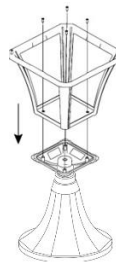

Fig.2



GS-105B-W

1. Use a drill to make two holes in the desired surface.
2. Place the screw anchors into the holes, place the lamp in line with the holes and secure with the provided screws.
3. Attach the base (H) to the Wall bracket (F) with the nut (Fig.3).
4. Attach the fixture (D) to the base (H) with the four supplied screws, as shown (Fig.4).

Fig.3

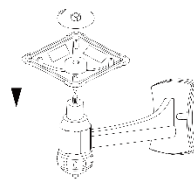
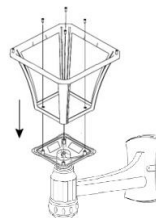
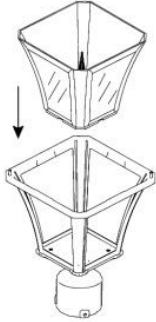

Fig.4



After assembling your specific bracket here are the steps to finish assembling your unit, this step applies to all three brackets:

1. Place the lens and cone (C) in the body (D).



2. Screw the GS LED lightbulb into the socket. Turn on switch to desired setting.

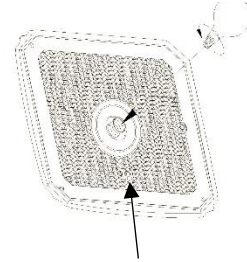

Operation Switch

3. Attach top(B) to the body(D) with the two supplied screw caps.

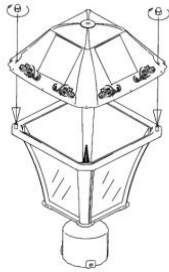

6. Screw on top ornament.



Operation Instructions

1. Remove the Top (B) by unscrewing the 2 screw caps. Screw the GS LED lightbulb into the socket. Turn on switch to desired setting high or low (for longer duration). The Solar Lamp will automatically operate at dusk.

2. Reattach the Top (B) and secure with the 2 screw caps.

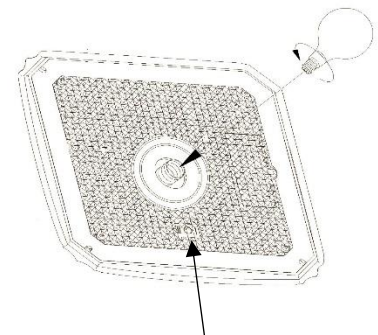

Operation Switch

Replacing the Batteries

(After several years of use, the battery may need replacing).

1. Unscrew the two screw caps and detach the top (B). Make sure the ON/OFF switch is in the OFF(O) position.
2. Unscrew the battery compartment (Fig.5) screw located on the silver reflector and remove the compartment cover.
3. Unclip the connector and remove the old battery. Make sure the new battery is a Gama Sonic - 3.2V/1,500mAh, Li-ion Rechargeable battery with connector.
4. Clip on new battery and install into the battery compartment. Reinstall battery compartment cover.
5. Reattach the top and secure with the 2 screw caps.

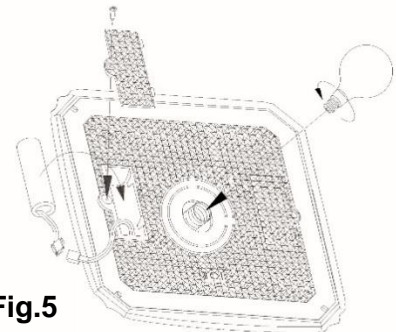

WARNING: Do not dispose of Li-Ion battery in the regular trash, municipal waste stream or by fire as batteries may leak or explode. Do not open, short circuit, or mutilate batteries as injury may occur. Preserve our environment by recycling Li-Ion batteries or disposing of them in accordance with local, State and federal regulations. Do not mix old and new batteries.

Maintenance

Clean the solar panels regularly with a damp towel to guarantee optimum performance. Do not use any type of solvent for cleaning and be careful not to put too much pressure on the solar panels while cleaning.

Trouble Shooting

If your solar charged light does not come on at dusk despite observance of all the instructions, please try the following steps:

1. Make sure that the solar lamp is not being affected by any other light source.
2. Ensure the solar lamp is not positioned in the shade during the day.
3. Make sure the switch on the lamp head is in either the Low or High position.
4. Check that the batteries are installed correctly.

NOTE: The performance of the solar lamp will vary with the time of year. It will deliver more light when it has had a full day in the sun rather than a day in overcast weather.

WINTERTIME TIPS: For optimal performance, be sure to remove any snow or debris accumulation from solar panel(s). A solar panel free of debris will charge the batteries much more efficiently.

WARNING: Please keep out of reach of children.

